

YAMAHA MRX-70

Learning-Capable Multi-function Remote Control

Télécommande multi-fonctions programmable

CENTER

MEMORY MAX

OWNER'S MANUAL
MODE D'EMPLOI

ENGLISH

CAUTION: READ THIS BEFORE OPERATING THIS UNIT.

1. To ensure proper operation and maintenance, please read this instruction manual thoroughly. Once you have read it, keep it in a safe place for future reference.
2. This unit is a sophisticated remote control transmitter. Do not drop, hit, or subject it to other shocks.
3. Do not operate or store this unit in or near the following:
 - a. Sources of heat such as radiators, heaters, direct sunlight, etc.
 - b. Sources of cold such as air conditioners, etc.
 - c. Sources of moisture such as sinks, bath tubs, showers, aquariums, etc.
4. Do not attempt to use solvents to clean this unit; this might damage the finish. Use a clean dry cloth.
5. Never open the unit yourself for any reason. No user serviceable parts are inside. If you encounter problem, refer to page 6. If the unit is still defective after checking those points, contact your YAMAHA dealer or service center.

FRANÇAIS

ATTENTION: LIRE CECI AVANT DE FAIRE FONCTIONNER VOTRE UNITÉ.

1. Pour garantir un fonctionnement et un entretien corrects, lire ce manuel avec attention. Une fois lu, le garder dans un endroit sûr pour une référence future.
2. La unité est un émetteur de télécommande sophistiqué. Ne pas le laisser tomber, le cogner ni le soumettre à des chocs.
3. Ne pas faire fonctionner ni entreposer la unité dans ou près des endroits suivants:
 - a. Sources de chaleur comme un radiateur, le plein soleil, etc.
 - b. Sources de froid comme un climatiseur, etc.
 - c. Sources d'humidité comme des éviers, baignoires, douches, aquariums, etc.
4. Ne pas essayer de nettoyer la unité avec un solvant chimique car ceci risque d'endommager le fini. Utiliser un chiffon propre et sec.
5. Ne jamais ouvrir l'appareil vous-même. Il n'y a aucune pièce réparable par l'utilisateur à l'intérieur. Si votre appareil est défectueux, se référer à la page 17. Si le problème persiste après vérification de ces points, contacter votre concessionnaire ou centre de service YAMAHA.

IDENTIFICATION OF PARTS/DENOMINATION DES PIECES

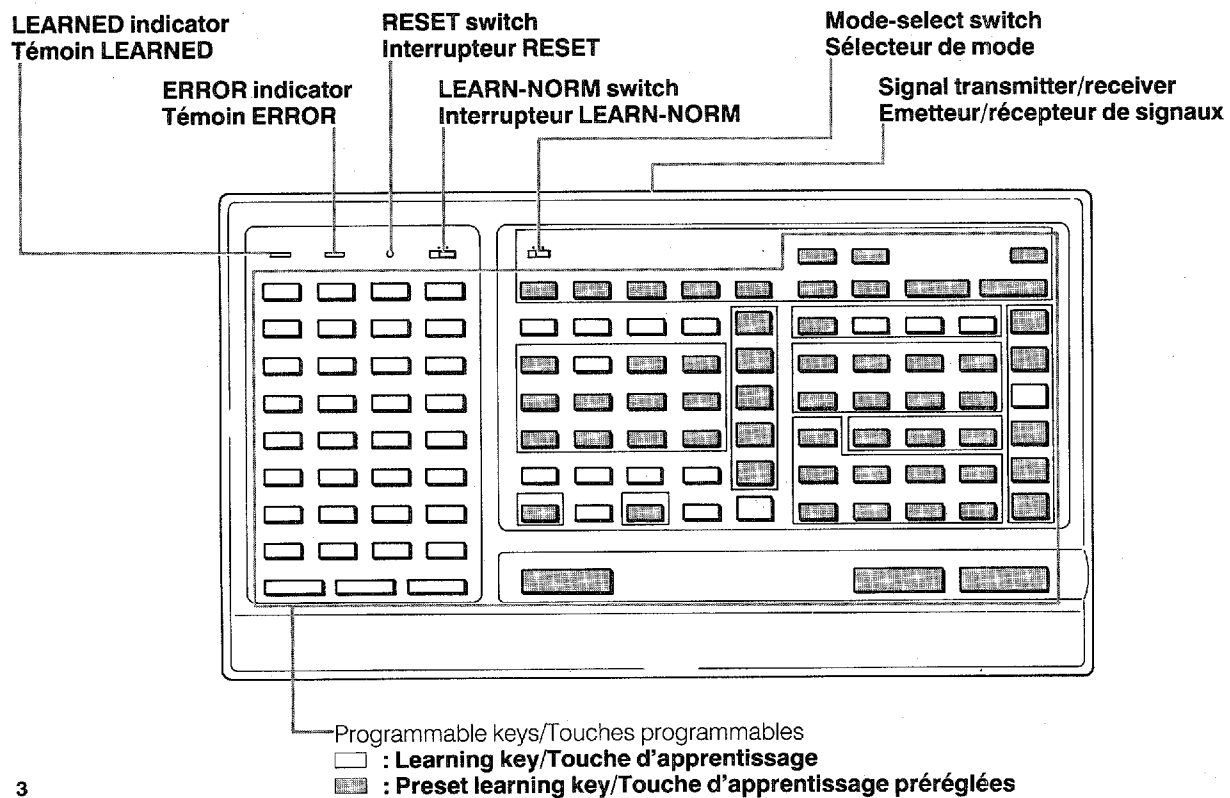

Thank you for purchasing the YAMAHA remote control transmitter.

This remote-control transmitter has a number of programmable keys. These keys can be programmed to "learn" the signal patterns from other remote-control transmitters. By programming this unit with the signals from other remote-control transmitters, this unit can then be used in place of one or more other remote-control transmitters, thus making operation of your various audio and video components more convenient.

There are two types of programmable keys. (See page 3.)

: **Learning keys**

These keys have not yet been programmed with any type of signal.

: **Preset learning keys**

These keys have already been programmed with signals for operation of YAMAHA components that bear the "SRIS" mark.

Either of these keys can, by the same method, be programmed with signals from other remote-control transmitters.

NOTE

There may occasionally be instances in which, due to the signal-coding and modulation systems employed by the other remote-control transmitter, that this unit will not be able to "learn" its signals.

**TO PROGRAM SIGNALS FROM OTHER
REMOTE-CONTROL TRANSMITTERS → See P.5.**

- * The included label sheets can be used to indicate the functions of programmed keys. Refer to page 5 for details.

**TO OPERATE YAMAHA COMPONENTS THAT BEAR
THE "SRIS" MARK BY USING PRESET FUNCTIONS OF
THIS UNIT → See P.8.**

- * If the preset learning keys are to be used as a group together, the included indication sheets are convenient.

TO PROGRAM SIGNALS FROM OTHER REMOTE-CONTROL TRANSMITTERS

Before programming

- * Use the included label sheets to indicate the functions for which learning keys have been programmed. It is recommended that you first determine the best and most convenient layout of the keys for the various functions you plan to program (and attach the labels accordingly), and then program the keys correspondingly.
- * Some learning keys are larger than others, but all keys are potentially capable of the same functions if so programmed. Keys should be programmed and used according to their positional convenience.

Follow the steps described below to program signals from other remote-control transmitters to this unit.

1. Set the LEARN-NORM switch to the "LEARN" position.

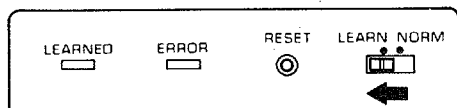

2. Position this unit and the other remote-control transmitter head to head. About 5 - 10 cm (2 - 4 in.)

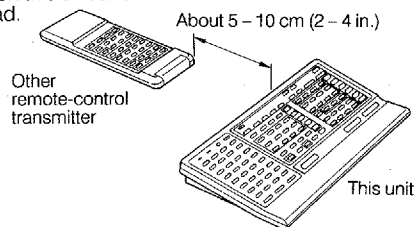

3. Press the learning key (or preset learning key) on this unit to which the programming will be made.

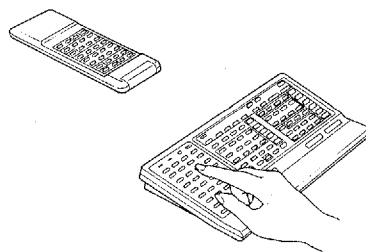

- * If the pressed key is unprogrammed, the LEARNED indicator will flash continuously. If the key is already programmed, the LEARNED indicator will flash continuously and, at the same time, the ERROR indicator will illuminate. Then proceed to the next step if you want to change that instruction already programmed for the key. If you do not want to change it, however, press the key to be programmed next and proceed to the "learning" operation of that key.

4. Press the key (on the other remote-control transmitter) for the function to be programmed.

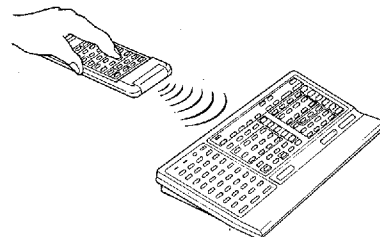

* The LEARNED and ERROR indicators will illuminate continuously while the signals from the other remote-control transmitter are being received by this unit. Press and hold the key on the other remote-control transmitter until the illumination of these indicators stops. The LEARNED indicator will illuminate for about two seconds when the programming of signals has been successfully completed.

5. Repeat steps 3 and 4 until the signals for all programmings you want to make are successfully programmed.
6. After all programming is completed, set the LEARN-NORM switch to the "NORM" position.

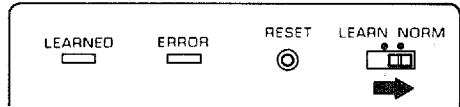

After all programming is completed, try operating this unit.

NOTES

- Note that the successful programming of signals to a learning key (or preset learning key) results in the erasure of previously programmed signals and their replacement by the newly programmed signals.
- In step 4, If the key on the other remote-control transmitter is not pressed within 15 seconds after a learning key is pressed, this unit will automatically return to the status that was in effect before the learning key was pressed.
- If the signals are not successfully programmed to this unit, the ERROR indicator will flash for about two seconds. If signals to be programmed are too long and this unit cannot program them, this unit automatically expands the work area capacity to be doubled, and will then await the next entry. During this stand-by mode the LEARNED indicator flashes rapidly. If this happens, try programming again.

- Although, because this unit employs the variable length programming method, long signals can also be programmed, if all signals programmed are long signals, it might happen that the capacity of the memory area would be completely used before all keys that are programmable are actually programmed, and no further programming would be possible. If this happens, after the signals from the other remote-control transmitter is received (in step 4), the LEARNED indicator and the ERROR indicator will flash two times.

Trouble shooting guide

If programming cannot be made successfully, or if this remote-control transmitter does not function even though the programming was successful, check the following points:

- * Check whether the batteries of the other remote-control transmitter are weak.
Note that even though its batteries may be strong enough to operate the component it was made for, they may be too weak to transfer signals to this unit. If so, replace the batteries of the other remote-control transmitter.
- * Check whether the distance between the two remote-control transmitters is too long or too short.
- * Check whether a strong light, such as direct sunlight, is striking the signal transmitter/receiver of this unit.

HOW TO CLEAR SIGNALS PROGRAMMED BY THE LEARNING OPERATION

By using the RESET switch, signals that you have programmed to a learning key or to a preset learning key can be canceled. When the RESET switch is used for cancellation, learning keys are then unoccupied by programming, and preset learning keys return to their preset status.

To cancel the programming of a certain key, or to return it to the preset programming (applicable only to preset learning keys)

1. To cancel key programmings, set the mode-select switch to "ALL".

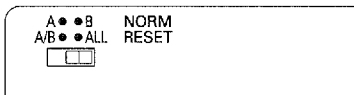

To return to preset programmings, set the mode-select switch to "A/B".

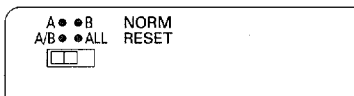

2. Set the LEARN-NORM switch to the "LEARN" position.

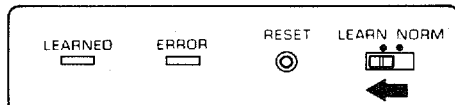

3. Press the RESET switch using the point of a mechanical pencil, etc. The LEARNED and ERROR indicators will illuminate for 15 seconds.

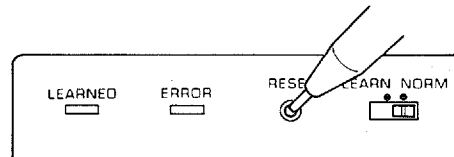

4. Press and then release the learning key (or preset learning key) for which you want the programmed signal to be canceled. The LEARNED indicator's illumination and the ERROR indicator's illumination will then stop. Then, when the cancellation is finished, the LEARNED indicator will illuminate for one second. This indicates the completion of the cancellation process. To cancel two or more programmings, repeat steps 2 and 3.

NOTE

If a learning key (or a preset learning key) is not pressed within 15 seconds after the RESET switch is pressed, this unit will automatically return to the status that was in effect before the RESET switch was pressed.

To cancel all key programmings at one time, or return all preset learning keys to preset programmings

1. To cancel all key programmings, set the mode-select switch to "ALL".
To return all preset learning keys to preset programmings set the mode-select switch to "A/B".
2. Set the LEARN-NORM switch to the "LEARN" position.
3. Press the RESET switch using the point of a mechanical pencil, etc.
The LEARNED indicator and ERROR indicator will then begin continuous flashing. Press and hold (about 5 seconds) until the flashing stops.
4. When the flashing stops, the cancellation process has started. Then, when the cancellation is finished, the LEARNED indicator will illuminate for one second.
This indicates the completion of the cancellation process.
* If programmings are made until the programming capacity is full, about 20 seconds will pass before the LEARNED indicator illuminates steadily.

NOTE

If, in step 3, the switch is accidentally released before the flashing stops, the unit will change to the pre-described mode for cancellation of certain programmings (or return to the preset programmings). If this happens, about 15 seconds would be required to return to the mode for cancellation of programmings of all keys (or returning to preset programmings) if the reset switch is once again pressed and held, so the better way is to follow the steps below.

1. Press the desired learning key (or preset learning key) to end the cancellation operation.
2. Set the LEARN-NORM switch to the "NORM" position, and then begin the cancellation operation again from the beginning.

PRESET LEARNING KEYS

Among the programmable keys with which this unit is provided, those keys (shaded in the figure on page 3) have been preset with signals for operation of only YAMAHA components bearing the  identification mark.

There are two types (mode A and mode B) of preset signals for the preset learning keys.

When using, set the mode-select switch to the position corresponding to the YAMAHA component to be used.

For components receiving remote-control signals via a cable from the amplifier or other equipment, set to the mode applicable to the amplifier.

● **Components operable at mode A:**

Receivers, integrated amplifiers and component systems bearing the  mark.

● **Components operable at mode B:**

AVC-50 and AVX-100U

● **Components operable at either mode:**

Turntables, compact-disc players, cassette decks, CDV/video disc players, graphic equalizers, etc. bearing the  mark.

NOTE

If the preset learning keys are to be used as a group together, use the included indication sheet for mode A or for mode B. [Depending on the component, there may be instances in which there are some differences between the indication and the actual function, or instances in which there is no corresponding function. If so, a label matching the actual function could be attached, or an unneeded key could be cleared (by using the individual key cancellation procedure) and programming made to the key you want to change.]

The included "BLANK SHEET" can be conveniently used when preset learning keys are programmed.

ABOUT THE PRESET FUNCTIONS

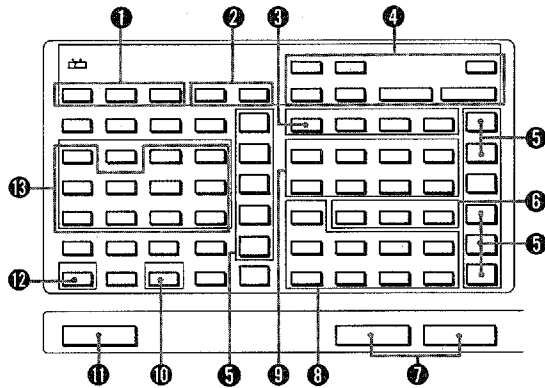

1 Graphic-equalizer keys

These keys can be used for operation of a YAMAHA graphic-equalizer (such as model EQ-630, etc.) if it includes the presetting function.

EQ ON/FLAT key

This key can be used to select whether or not to use the circuitry of a graphic-equalizer.

PRESET UP/DOWN keys

These keys can be used to select any of the preset "channels".

2 PICTURE UP/DOWN keys

These keys are used to select the video source you wish to monitor. These keys are preset with signals for mode B only.

3 PLAY/CUT key

This key can be used to start or stop disc play on a turntable (with the  mark). This key functions in the same manner as the PLAY/CUT key on the turntable itself. Press it once to start play, and once again to stop play.

4 SURROUND key

DELAY TIME UP/DOWN keys

These keys have the same function as the SURROUND PROCESSING MODE DELAY TIME button on the amplifier or other component.

ON/OFF key

This key has the same function as the SURROUND PROCESSING MODE ON/OFF button on the amplifier or other component.

SURROUND MODE keys

These keys are used to select the SURROUND PROCESSING MODE. Press the UP key to increase the number of the SURROUND PROCESSING MODE. Press the DOWN key to decrease the number of the SURROUND PROCESSING MODE.

REAR LEVEL UP/DOWN keys

These keys are used to increase or decrease the output level of the rear speaker pair.

5 Input selector keys

These keys are used to select the sound source.

6 Tuner keys

These keys are used to select one of the preset broadcast stations.

A/B/C key

This key is used to select one of the three preset ranges. The range changes each time the key is pressed.

UP key

Press this key to select the desired station within the selected range. The preset ("P") number increases by one each time the key is pressed.

DOWN key

Press this key to select the desired station within the selected range. The preset ("P") number decreases by one each time the key is pressed.

7 MASTER VOLUME control keys

These keys are used to increase or decrease the output volume level of both speaker pairs.

8 Cassette tape deck keys

A cassette tape deck that bears the **ARS** mark can be controlled by using these keys.

DECK A/B key

Press this key to select either deck A or deck B if the deck is a double-cassette deck.

key

Press this key to rewind the tape.

PLAY key

Press this key to start tape playback. If the deck is a double-cassette deck, the tape in the deck that played back most recently will begin playback when this key is pressed.

key

Press this key to fast-forward the tape.

REC/PAUSE key

Press this key to set the cassette tape deck to the recording-pause mode.

STOP key

Press this key to stop the tape movement.

REC MUTE key

Press this key to make a non-recorded space on the tape while a recording is in progress.

DIR A key (for use with a double-cassette deck only)

Press this key to change the direction of movement of the tape in cassette tape deck A.

DIR B key (for use with a double-cassette deck only)

Press this key to change the direction of movement of the tape in cassette tape deck B.

9 Compact-disc player keys

A YAMAHA compact-disc player that bears the **ARS** mark can be controlled by using these keys.

SKIP key

Press this key to advance to the beginning of the next track on the disc.

SKIP key

Press this key to return to the beginning of the track now playing. If this key is pressed at the beginning of a track, play will begin from the beginning of the previous track.

SEARCH  key

Press this key to advance rapidly.

SEARCH  key

Press this key to move rapidly in the reverse direction.

DISC UP/DOWN keys

These keys are used for selection of the disc, and are applicable only to compact-disc players that have the magazine type of automatic disc-changing mechanism.

PAUSE/STOP key

This key is used to stop (or temporarily stop: pause) the compact-disc player operation.

Play stops temporarily when the key is pressed once, and changes to a complete stop when the key is pressed again.

PLAY key

Press this key to start compact-disc play.

 MUTING (-20 dB) key

Press this key to mute the sound level by 20 dB. Press the key again to resume original sound level.

This key is very convenient for lowering the volume level temporarily (for instance, to answer a phone call) without disturbing the original volume level setting.

 POWER key

Press this key to switch ON or OFF the power of an amplifier or other component.

 SLEEP key (for mode A)/DISPLAY key (for mode B)**SLEEP key**

The power to an amplifier or other component is automatically switched OFF one hour after this key is pressed.

DISPLAY key

Press this key to display the mode of the amplifier on the monitor screen. You will then be able to determine the present mode at a glance without checking the indicators or the settings of controls and buttons.

 CDV/video disc player keys

A YAMAHA compact-disc/video disc player (such as model CDV-1600, CDV-2000, etc.) that bears the  mark can be directly controlled by using these keys.

OPEN/CLOSE key

Press this key to open or close the disc tray.

PAUSE/STOP key

Press this key once to temporarily stop the CDV player operation; when it is pressed again, the CDV player changes to the stop mode.



PLAY key

Press this key to start the CDV disc or video disc play.

CHAPTER keys

- + When this key is pressed during CDV disc or video disc play, the beginning of the next "chapter" is detected.
- When this key is pressed during CDV disc or video disc play, the beginning of the "chapter" now playing is detected.

SEARCH keys

-  When this key is pressed during CDV disc play, compact-disc play, or video disc play, play is advanced at high speed.
-  When this key is pressed during CDV disc play, compact-disc play, or video disc play, play is reversed at high speed.

STILL keys (CAV)

- ▷ This key is used to display a still picture or for frame-by-frame play in the forward direction during video (CAV) disc play.
- ◁ This key is used to display a still picture or for frame-by-frame play in the reverse direction during video (CAV) disc play.

SOUND select key (Video disc)

This key can be used to select the sound to be played from the disc and which will be output from the left and right audio signal output jacks.

The selected audio signal changes in the order: STEREO →1/L-CH →2/R-CH each time the key is pressed.

DISPLAY key

When this key is pressed during the play of a video (CAV) disc, the "chapter" and frame numbers of the picture now being viewed are displayed on the screen.

When this key is pressed during the play of a video (CLV) disc, the "chapter" number and the time are displayed on the screen.

When this key is pressed during the play of a compact disc or a CDV disc, the total time, remaining time or track time is displayed on the screen.

REMOTE-CONTROL OPERATION

Note the following points when using this unit for operation of audio/video-equipment.

- Be sure to set the LEARN-NORM switch to the "LEARN" position.
- If this unit is not faced toward the component to be operated and the key pressed correctly so that the correct signal can be transmitted, the LEARNED indicator will illuminate steadily. The ERROR indicator will illuminate if an unprogrammed key is pressed, or two or more keys are pressed simultaneously or one after another.
 - * If a short signal is transmitted by a learning key (or preset learning key), this indicator's illumination will stop when signal transmission ends, even if the key is pressed for a longer time.

OPERATION RANGE

This remote-control transmitter must be faced toward the component to be controlled, and be within a range of about 7 meters (23 feet) for proper operation.

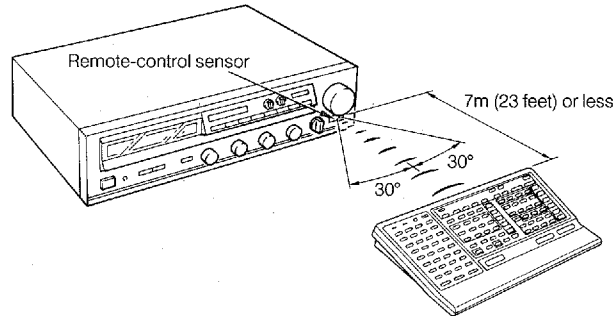

BATTERY INSTALLATION/REPLACEMENT

- The remote-control transmitter's batteries are too weak if the LEARNED indicator and the ERROR indicator do not illuminate or flash, or if the distance or range within which the remote-control transmitter can be used decreases. If either occurs, replace the batteries with new ones.
- Install the batteries as shown below.

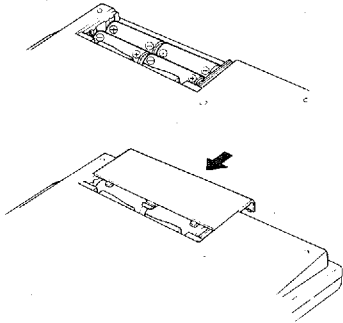

- Be sure to follow the diagram in the battery compartment to assure proper positive (+) and negative (-) polarity.
- Do not use old and new batteries at the same time.
- If a battery leaks, dispose of all batteries; then clean the battery compartment thoroughly before installing new batteries.

Memory back-up

All of the programmed functions will be retained while you replace the batteries. However, if no batteries are installed for a few hours, the memory will be erased and will have to be programmed again.

SPECIFICATIONS

Dimensions (W x H x D)	210 x 31.6 x 118 mm (8-1/4" x 1-1/4" x 4-5/8")
Weight	265 g (9 oz.)
Accessories included	Four AA (R06) batteries Indication sheets Label sheets (6 colors) Tweezers

YAMAHA

YAMAHA CORPORATION
10-1, Nakazawa-cho, Hamamatsu, 430 Japan
VH58430-0 BWgW,O Printed in Japan®